

Kid Power

Activity Book

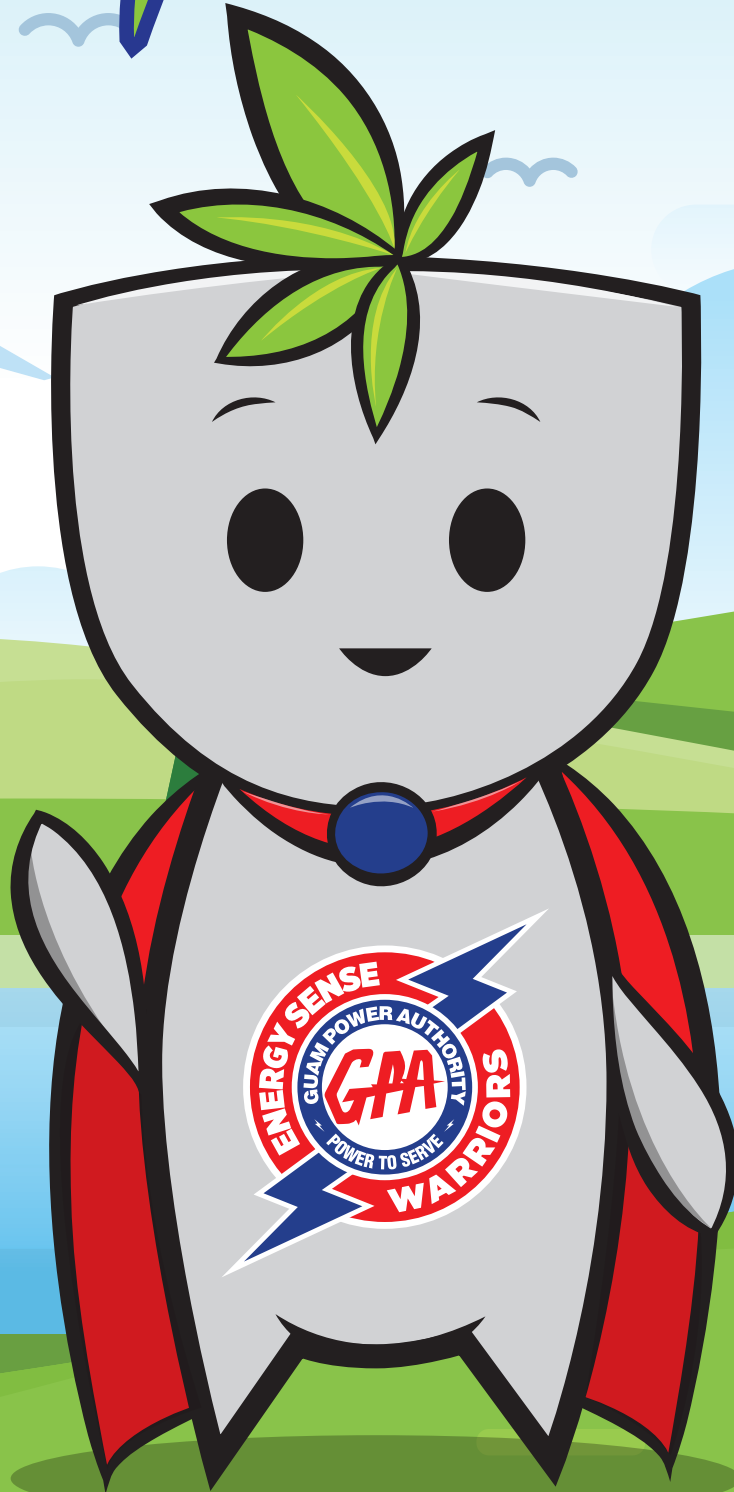

*Help Lightning Latte bring color to the
GPWA Fadian Customer Service Center.*



"Gloria B. Nelson Public Service Facility"

***16,000 square ft. structure**

***376 employees**

***Two agencies (GPA/GWA)**

***Providing an improved and convenient environment to better serve customer needs.**

A Brighter Future

GPA has been planning and moving to 100% renewables since 2006.

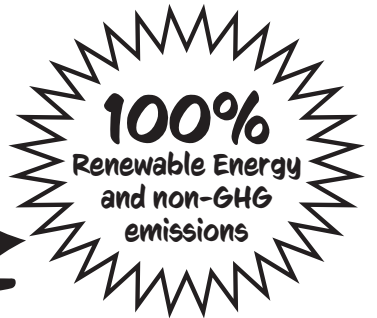
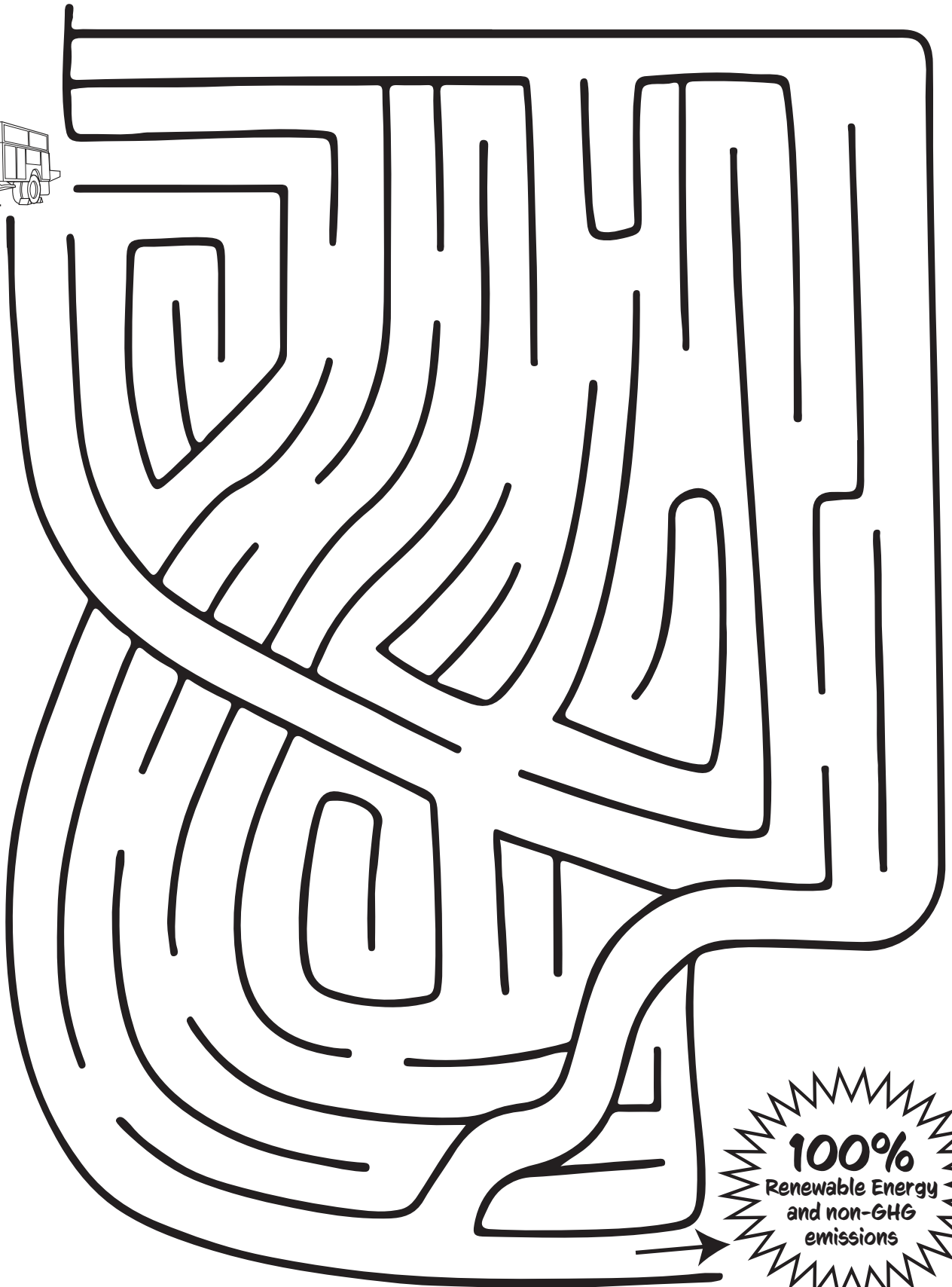
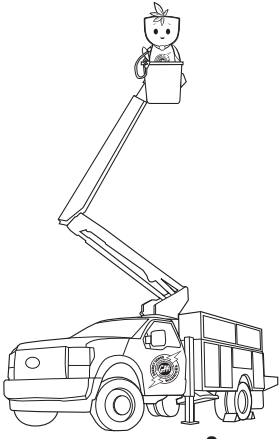

Another Bright Idea

Connect the dots to complete the cross-section of an LED bulb.

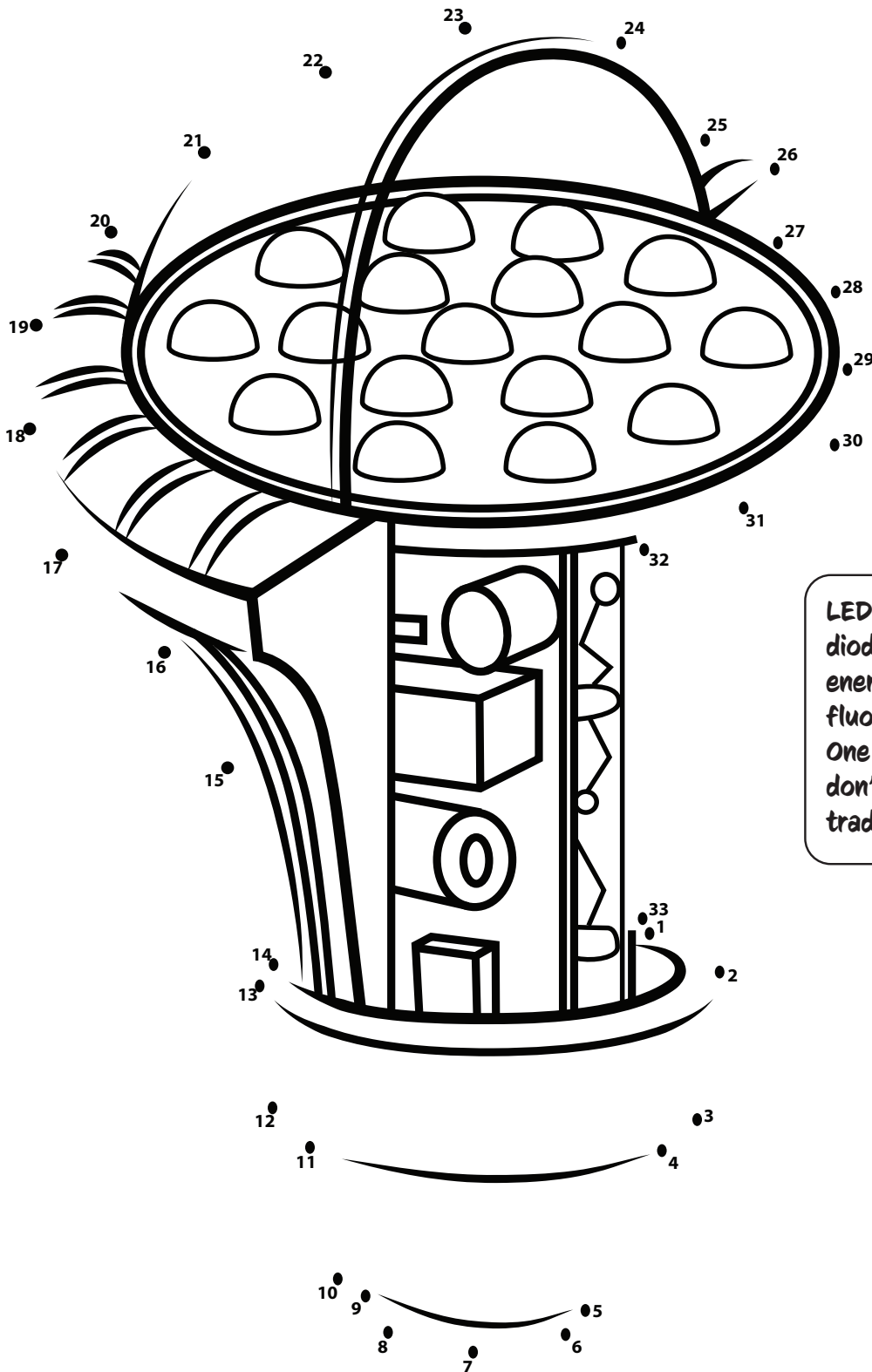

LED stands for light-emitting diode. LED light bulbs use less energy than incandescent and fluorescent bulbs and last longer. One big reason why is that they don't emit as much heat as traditional bulbs.



Clean & Green



Help the Powerees find renewable & efficient energy.

- | | | |
|-------------|--------------|-------------|
| BIOMASS | HYBRID | SUSTAINABLE |
| LED | HYDRO | TURBINE |
| CLEAN | HYDROGEN | WATT |
| CONSERVE | KILOWATT | WEATHERIZE |
| EFFICIENT | PHOTOVOLTAIC | WIND |
| ELECTRICITY | POWER | |
| ENERGY | RENEWABLE | |
| FOSSIL | RESOURCE | |
| FUEL | SAVE | |
| GENERATE | SCIENCE | |
| GEOTHERMAL | SOLAR | |
| GREEN | STAR | |

An Energy Saving Tip

A great way to save energy is to turn off your video game system when you're done playing.



Use a power strip to eliminate energy sneakers (phantom or vampire loads) by conveniently turning off devices not in use such as cell phone chargers and other electronics.

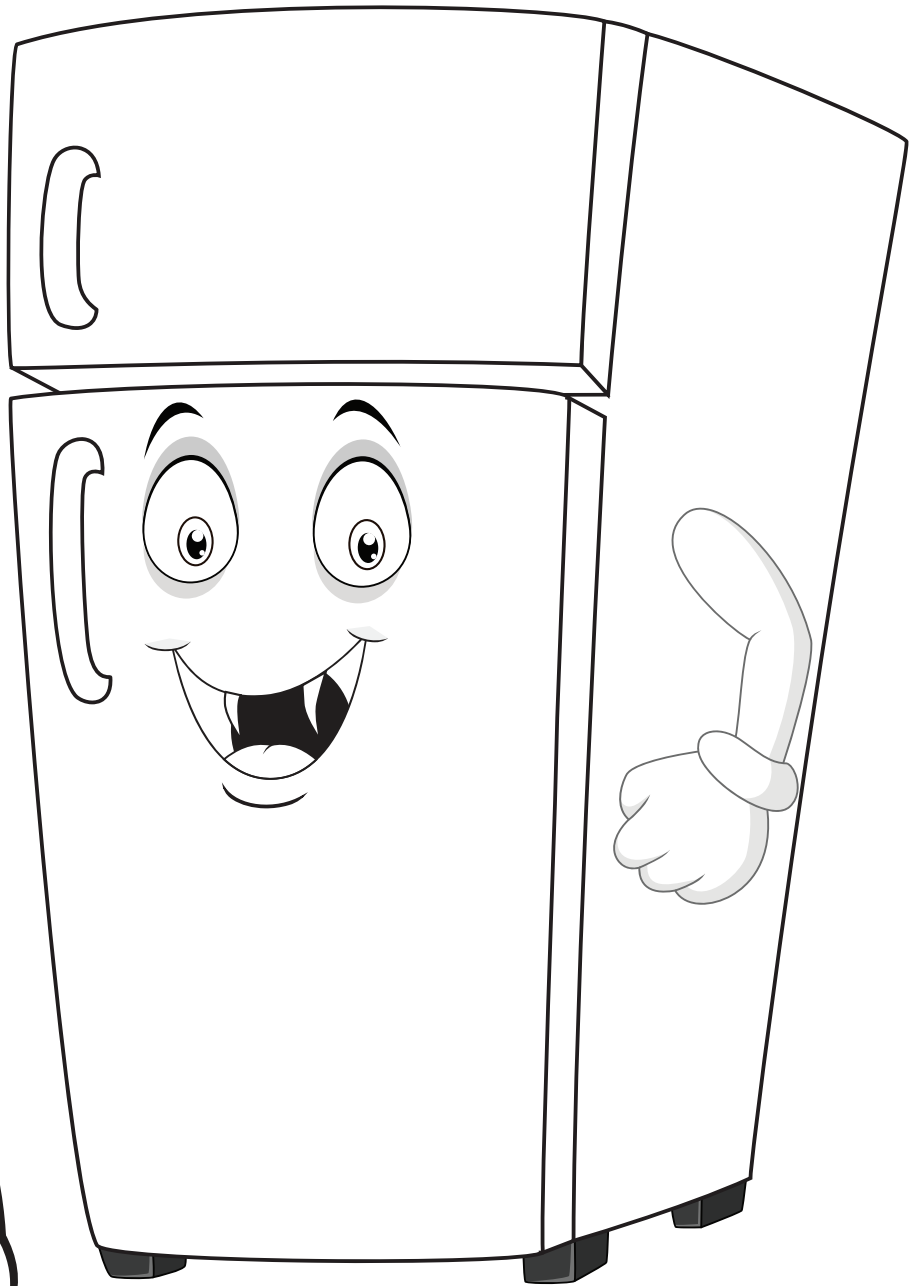

What do appliances dress up as for Halloween?

A: Energy Vampires

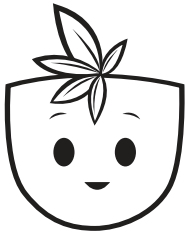

Energy Saver Crossword

Solve each crossword clue by filling in the blanks to complete the energy saving tip.

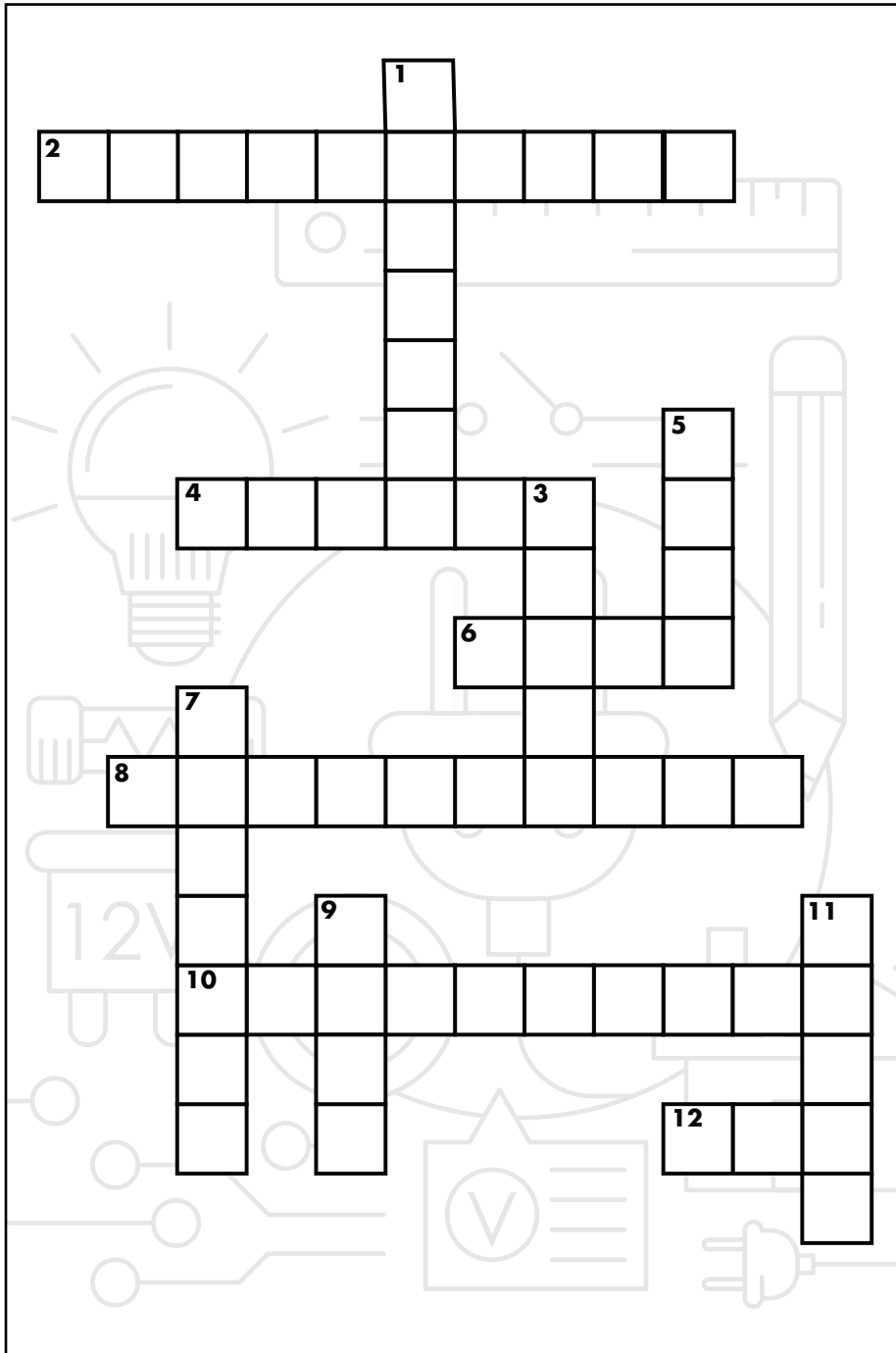

Across

2. The _____ in your home, like your refrigerator, need energy to work.
4. Always keep the refrigerator door _____.
6. Lingering moisture in your home's walls and floors can lead to the growth of _____.
8. You can reduce the amount of energy used by your heating and cooling system by adjusting the temperature on the _____.
10. When you're shopping for energy efficient appliances, look for items with an _____ label.
12. Turn _____ the TV when you leave the room.

Down

1. Look around your home for leaky _____. Tell your parents if you spot any!
3. Close windows and exterior _____ tightly.
5. Heating water uses a lot of energy, so wash your clothes in _____ water as much as possible.
7. To save water, take short _____ instead of baths.
9. When you shop for lightbulbs, choose _____, the most energy efficient and longest-lasting type.
11. If you hear or feel a _____ blowing through a crack in the window, tell your parents so they can seal and weather-strip it.

Word List

- Mold
 - Appliances
 - Doors
 - Closed
- Faucets
 - LEDs
 - Draft
 - Showers
- ENERGY STAR
 - Off
 - Cold
 - Thermostat

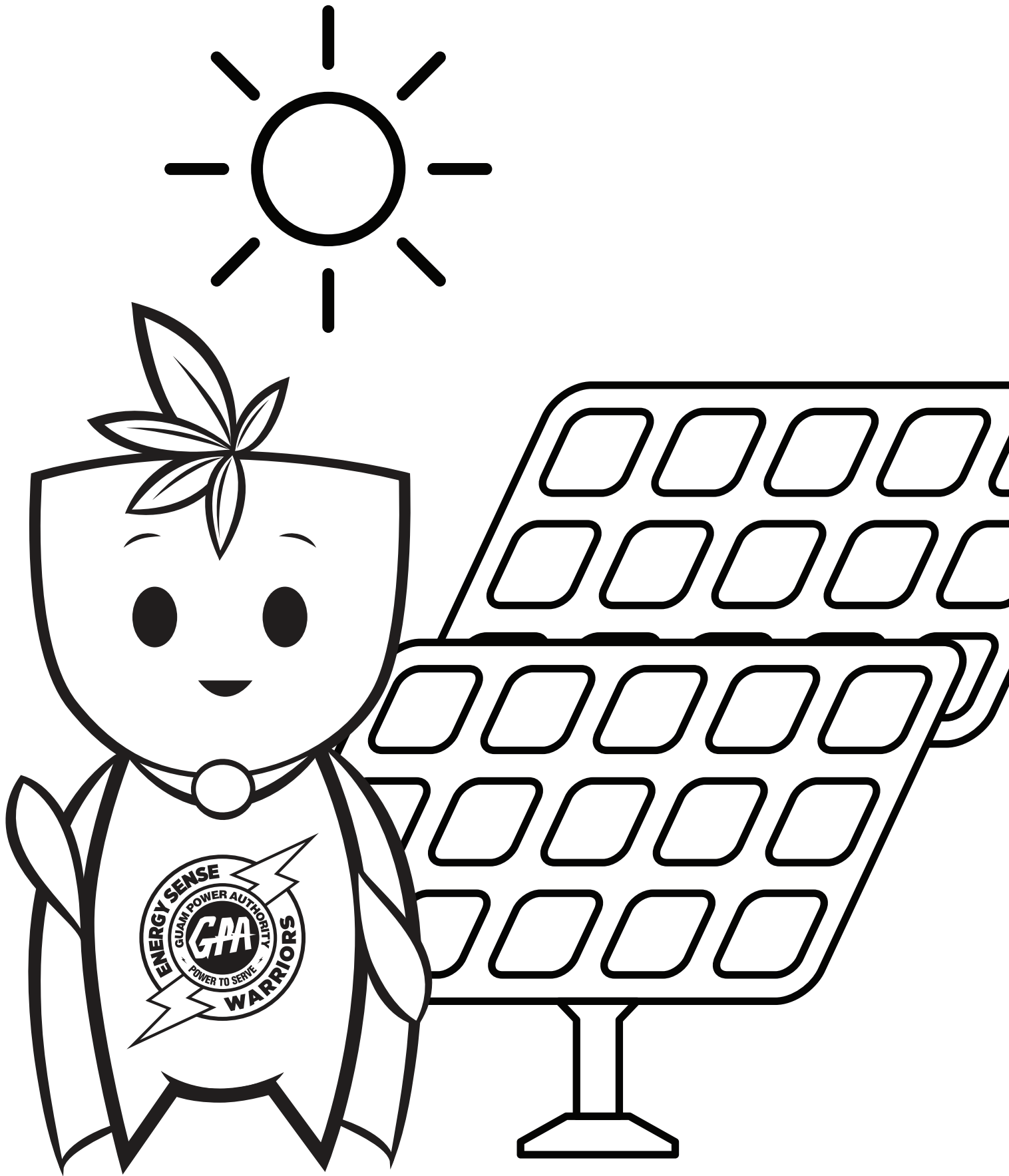

Who is the largest Solar PV Energy provider on Guam?

A: Biba GPAI



ENERGY
sense
Bringing energy solutions to you!



GUAM POWER AUTHORITY
ATURIDAT ILEKTRESEDAT GUAHAN

Hagatna Satellite Office
Julale Shopping Center Ste 103
424 West O'Brien Drive
Hagåtña, Guam 96910
Monday–Friday 8am–5pm
Closed on Weekends & Holidays
Phone: (671) 647-5787/8/9

Main Office
Gloria B. Nelson Public Service Building
688 Route 15 Fadian
Mangilao, Guam 96913
Monday–Friday 7am–5pm
Closed on Weekends & Holidays
Phone: (671) 647-5787/8/9

GPWA Upper Tumon Office
578 North Marine Corps Drive
Tamuning, Guam 96931
Monday–Friday 7:30am–6pm
Saturday 8am–12pm
Closed on Sundays & Holidays
Phone: (671) 647-5787/8/9

Website: www.guampowerauthority.com
Email us: customersfirst@gpagwa.com

Register to view your electricity usage:
www.myenergyguam.com



Design and original art by
Adztech Advertising & Public Relations, Inc.

Riddles provided by: U.S. Energy Information Administration